



## M10 / PM010

Looking equally smart from all angles thanks to its completely finished arm, the **M10** is the perfect 10. Relax and reflect in comfort, with this friendly, outstanding style with padded arms echoing the lines of the headrest. Be moved by its motion possibilities, and complete this look with a choice of polished chrome leg or wood leg in rich onyx or walnut, to match the table options.

### OPTIONS

---

#### LEG:

##### WOOD



ONYX



WALNUT

##### METAL



POLISHED STEEL

#### TABLE:

##### WOOD



ONYX



WALNUT

#### COVERS:

- All over leather
- All over Ultrasuede®

#### POWER:

- Power headrest included with power reclining mechanism
- Manual headrest included with stationary pieces

#### SEATS:

- Tight with attached seat
- Premium 2.2 lb high-density foam

#### BACKS:

- Tight with attached back
- Premium 2.2 lb high-density foam

#### FEATURES:

- High density foam backs
- Engineered wood, hardwood and softwood; all joints pinned and glued for uniformity and strength
- Adjustable articulating headrests

# M10 / PM004

Dimensions shown as Width x Depth x Height. Specifications are correct at time of printing and are subject to change without notice.  
LHF - left hand facing RHF - right hand facing IA - Inside arm to inside arm

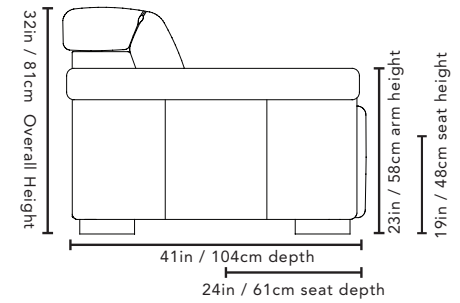

## PIECES

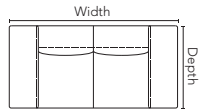

03 - Stationary Loveseat  
75in x 41in x 32in  
191cm x 104cm x 81cm  
IA = 51in / 130cm

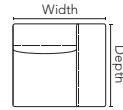

15 - RHF Wide Stationary End  
16 - LHF Wide Stationary End  
46in x 41in x 32in  
117cm x 104cm x 81cm

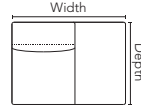

17 - RHF Stationary Nest  
18 - LHF Stationary Nest  
58in x 41in x 32in  
147cm x 104cm x 81cm

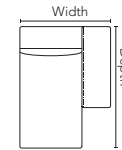

56 - RHF Chaise  
57 - LHF Chaise  
46in x 63in x 32in  
117cm x 160cm x 81cm

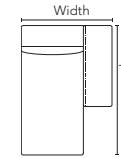

6L - RHF Chaise, Long  
7L - LHF Chaise, Long  
46in x 67in x 32in  
117cm x 170cm x 81cm

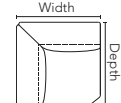

9H - Corner Square  
With Headrests  
47in x 47in x 32in  
119cm x 119cm x 81cm

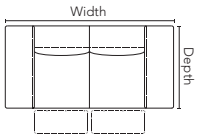

63 - Loveseat  
Recliner Power  
75in x 41in x 32in  
191cm x 104cm x 81cm  
IA = 51in / 130cm

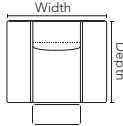

31 - Power Wallhugger  
Recliner  
50in x 41in x 32in  
127cm x 104cm x 81cm  
IA = 25in / 64cm

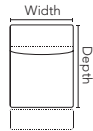

2P - Wide Armless  
Recliner  
34in x 41in x 32in  
86cm x 104cm x 81cm

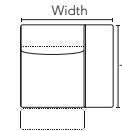

6P - RHF Wide Recliner Power  
7P - LHF Wide Recliner Power  
46in x 41in x 32in  
117cm x 104cm x 81cm

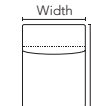

70 - Wide Armless  
Chair  
34in x 41in x 32in  
86cm x 104cm x 81cm

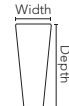

T0 - Table Top  
Angled Wedge  
18in x 41in x 21in  
46cm x 104cm x 53cm

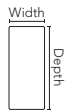

T2 - Table Top Straight Console  
13in x 41in x 21in  
117cm x 104cm x 53cm

## POPULAR CONFIGURATIONS

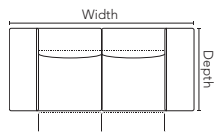

6P/7P  
92in x 65in / 234cm x 165cm

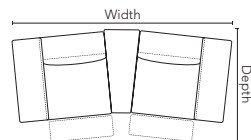

6P/T0/7P  
110in x 67in / 279cm x 170cm

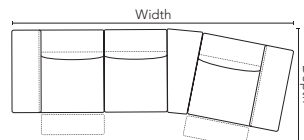

6P/70/T0/7P  
143in x 70in / 363cm x 178cm

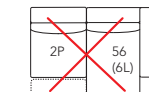

**\*CAUTION:**

2P Wide Armless Recliner with power should not be connected to 56, 57, 6L and 7L Chaise without table top wedge in between.

Measurements apply to reclining pieces only.

Wall Clearance = 2in / 6cm  
Depth in Full Recline = 65in / 165cm