

# FORTEBRACCIO

design  
Alberto Meda / Paolo Rizzatto

table / floor / wall

Practical and sturdy, Fortebraccio is the work lamp par excellence. Thanks to its innovative central joint, the lower and upper arms can rotate independently, allowing the lamp to assume the widest range of even extreme positions. The ergonomic grip at the top of the diffuser guides the smooth directional adjustment and contains the dimmer or switch, for easy control. Equipped with a universal attachment, Fortebraccio can be installed anywhere.

Pratica e robusta, Fortebraccio è la lampada da lavoro per eccellenza. Grazie all'innovativo snodo centrale, il braccio inferiore e quello superiore sono in grado di ruotare in totale autonomia, consentendo all'apparecchio di assumere le posizioni più diverse ed estreme. L'impugnatura ergonomica, posta sulla sommità del diffusore, ne guida il fluido orientamento e integra al suo interno il dimmer o l'interruttore, agevolando i comandi. Dotata di attacco universale, Fortebraccio si installa ovunque.

Praktisch und robust - Fortebraccio ist die ideale Arbeitsleuchte. Dank des innovativen zentralen Kugelgelenks können der untere und der obere Arm völlig unabhängig voneinander gedreht und ausgerichtet werden, lässt sich die Leuchte in die unterschiedlichsten und sogar in extreme Positionen bringen. Der ergonomische Griff am Kopf des Diffusors dient fließenden Ausrichtungsbewegungen, der darin integrierte Dimmer oder Schalter sorgt für einfache Steuerung des Lichts. Fortebraccio hat einen Universalanschluss und kann überall angebracht werden.

Pratique et robuste, Fortebraccio est la lampe de travail par excellence. Grâce à son articulation centrale innovante, le bras inférieur et le bras supérieur sont en mesure de pivoter en toute autonomie, permettant ainsi à l'appareil d'adopter les positions les plus variées et extrêmes. La poignée ergonomique, située sur le sommet du diffuseur, guide son orientation fluide et intègre à l'intérieur le gradateur ou l'interrupteur, facilitant ainsi les commandes. Équipée d'une fixation universelle, Fortebraccio s'installe partout.

Práctica y robusta, Fortebraccio es la lámpara de mesa por excelencia. Gracias a la innovadora articulación central, los brazos inferior y superior pueden rotar con total autonomía, permitiendo al aparato asumir las posiciones más variadas y extremas. El mango ergonómico se sitúa en la cima del difusor, guía la orientación fluida de este e integra en su interior el regulador de luz o el interruptor, facilitando los mandos. Con su sistema de fijación universal, Fortebraccio se instala en cualquier lugar.





## table



Fortebraccio represents new parameters in efficiency and user-friendliness for office lamps. The central joint allows the two arms to rotate independently on the horizontal and vertical axes, guaranteeing great fluidity of movement even in extreme and unusual positions. The polycarbonate grip enables users to maneuver the lamp simply and manageably.

1998

arms 44 + 35,5 cm  
head Ø 11 or Ø16 cm  
base Ø 23,6 cm

injection-moulded grip

moulded polycarbonate sheared  
and formed steel arms

die-cast metal joints

alu, black soft-touch, glossy white

max 60W E14  
max 100W E27  
28/42W spot energy saver  
42/70W halogen energy saver

Fortebraccio fissa nuovi parametri di efficienza e praticità per le lampade da lavoro. Lo snodo centrale permette ai due bracci di ruotare indipendentemente sull'asse orizzontale e verticale, garantendo grande fluidità di movimento anche in posizioni estreme e inconsuete. L'impugnatura in policarbonato consente di manovrare la lampada con semplicità e maneggevolezza.

Fortebraccio setzt neue Maßstäbe für Effizienz und Zweckmäßigkeit von Gelenkarmleuchten. Das zentrale Gelenk ermöglicht es, die beiden Arme unabhängig voneinander auf der waagrechten und senkrechten Achse auszurichten. Das sorgt für fließende Bewegungen auch in extreme und ungewöhnliche Stellungen. Der Griff aus Polykarbonat sorgt für einfache und praktische Handhabung der Leuchte.

Fortebraccio fixe de nouveaux paramètres de performance et de praticité pour les lampes de bureau. L'articulation centrale permet aux deux bras de tourner indépendamment sur l'axe horizontal et vertical, assurant une grande fluidité de mouvement pour des positions extrêmes et inhabituelles. La poignée en polycarbonate permet de manœuvrer la lampe simplement, avec une grande maniabilité.

Fortebraccio fija nuevos parámetros de eficacia y practicidad para las lámparas de sobremesa. La articulación central permite a los dos brazos girar independientemente sobre el eje horizontal y vertical, garantizando gran fluidez de movimiento incluso en posiciones extremas e insólitas. La empuñadura de policarbonato permite maniobrar la lámpara con simplicidad y facilidad.



## floor

The floor version of the famous work lamp that extends its operating range and its renowned functionality, enhanced by the practical polycarbonate grip housing the dimmer or on/off switch and allowing the light to be directed with great simplicity and precision.

1998

arm 35,5 cm  
head Ø16 cm  
h 92 cm, base Ø 23,6 cm

injection-moulded grip

moulded polycarbonate sheared  
and formed steel arms

die-cast metal joints

alu, black soft-touch, glossy white

max 100W E27  
70W halogen energy saver  
42W spot energy saver

La versione da terra della celebre lampada da lavoro ne amplifica il raggio d'azione e la proverbiale funzionalità, valorizzata dalla pratica impugnatura in policarbonato che incorpora il dimmer o l'interruttore e consente di orientare la luce con grande semplicità e precisione.

Die Stehleuchtenversion der berühmten Tischlampe, mit größerem Wirkungskreis und sprichwörtlicher Funktionalität. Zusätzlich verstärkt durch den praktischen Griff aus Polycarbonat mit Dimmer oder Schalter, der kinderleichtes und präzises Ausrichten des Lichts ermöglicht.

La version de sol de la célèbre lampe de table en amplifie le rayon d'action et la fonctionnalité proverbiale, valorisée par la poignée en polycarbonate, si pratique, qui intègre le gradateur de lumière ou l'interrupteur et permet d'orienter la lumière avec grande simplicité et précision.

La versión de pie de la famosa lámpara de sobremesa amplifica el radio de acción y la proverbial funcionalidad de la misma, valorizada por la práctica empuñadura de policarbonato que incorpora el dimmer o el interruptor y permite orientar la luz con gran simplicidad y precisión.



wall



This lamp comes in two-arm, one-arm and spotlight versions and is made of steel and thermoplastic materials.

The handy grip, which contains the switch or the dimmer, allows the user to manoeuvre the lamp easily and in a practical manner.

1998

arm 35,5 cm  
arms 44 + 35,5 cm  
head Ø 11 or Ø16 cm

injection-moulded grip

moulded polycarbonate sheared  
and formed steel arms

die-cast metal joints

alu, black soft-touch, glossy white

max 60W E14  
max 100W E27  
28/42W spot energy saver  
42/70W halogen energy saver

Disponibile nella versione a due bracci, un braccio e spot è realizzata in acciaio e materiali termoplastici. La comoda impugnatura che incorpora l'interruttore o il dimmer garantisce semplicità e praticità di movimento.

Diese Leuchte gibt es zwei armig oder ein armig – sowie als Spotlight-Versionen. Sie ist aus Stahl und thermoplastischen Kunststoffen gefertigt. Der handliche Griff, der den Schalter oder den Dimmer enthält, erlaubt dem Benutzer, die Leuchte leicht und auf eine praktische Weise zu manövrieren.

Disponibile dans la version à deux bras, un bras et spot, réalisée en acier et matériaux thermoplastiques. La poignée qui intègre l'interrupteur ou le variateur assure une grande maniabilité.

Disponibile en la versión dos brazos, un brazo y spot, está realizada en acero y materiales termoplásticos. La cómoda empuñadura que incorpora el interruptor o el dimmer garantiza simplicidad y practicidad de movimiento.

**D33 FORTEBRACCIO**

EEI

D33Ns.60  
D33Nt. 100D

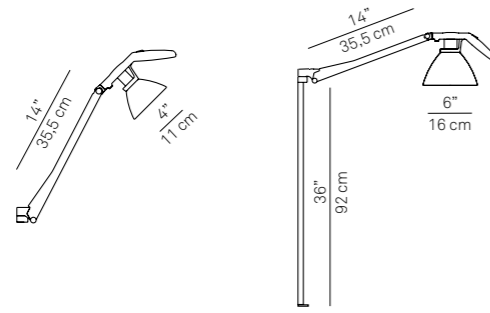

D33Ns.60

D33Nt. 100D

- Lamp D33Ns.60 **A+/A/D**
- 28W Spot R50 E14 energy saver **D**
  - 42W HSGSA E14 energy saver **D**
- Lamp D33Nt. 100D
- 42W Spot R63 E27 energy saver **D**
  - 70W HSGSA E27 energy saver **D**

D33Nsp. 60  
D33Nsp. 100

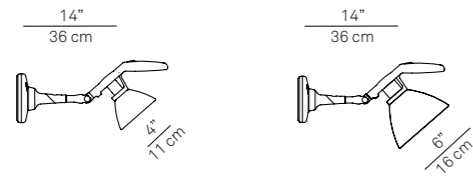

- Lamp D33Nsp.60 **A+/A/D**
- 28W Spot R50 E14 energy saver **D**
  - 42W HSGSA E14 energy saver **D**
- Lamp D33sp. 100
- 42W Spot R63 E27 energy saver **D**
  - 70W HSGSA E27 energy saver **D**

Accessories

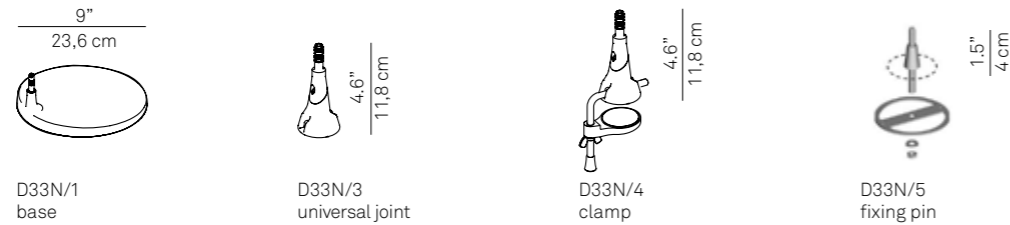

D33N/1  
base

D33N/3  
universal joint

D33N/4  
clamp

D33N/5  
fixing pin

Materials

injection-moulded grip /moulded polycarbonate sheared and formed steel arms die-cast metal joints

Structure finishes

glossy white black soft-touch alu

Insulation class



Note

the base D33N/1 only for D33Nt. 100D

for photometric data see [www.luceplan.com](http://www.luceplan.com)

**D33 FORTEBRACCIO**

EEI

D33N.60

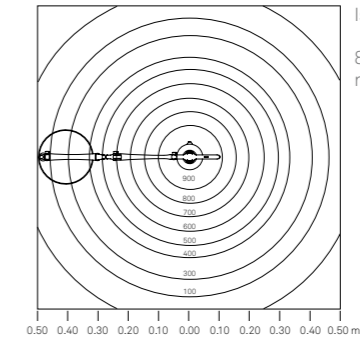
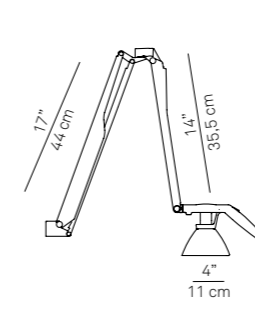

Isolux  
820lm - h 40cm  
max Lux = 950lx

- Lamp D33N.60 **A+/A/D**
- 28W Spot R50 E14 energy saver **D**
  - 42W HSGSA E14 energy saver **D**

D33N.100  
D33N.100 D

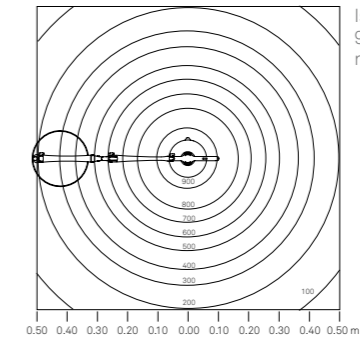
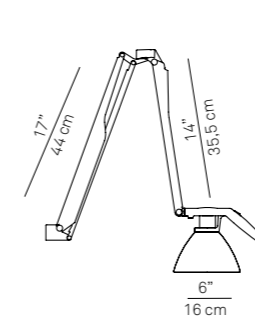

Isolux  
900lm - h 40cm  
max Lux = 937lx

- Lamp D33N.100 **A/D**
- 42W Spot R63 E27 energy saver **D**
  - 70W HSGSA E27 energy saver **D**
- Lamp D33N.100 D
- 42W Spot R63 E27 energy saver **D**
  - 70W HSGSA E27 energy saver **D**

Accessories

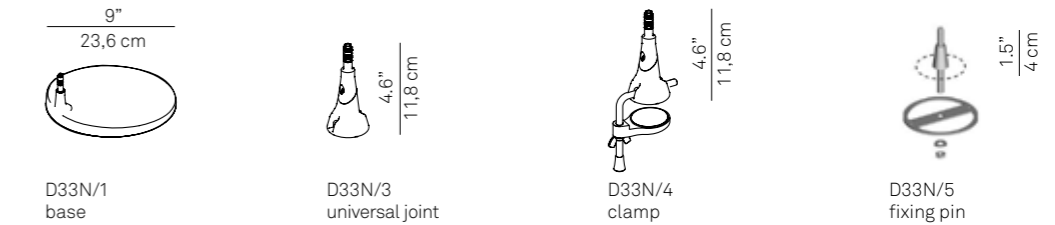

D33N/1  
base

D33N/3  
universal joint

D33N/4  
clamp

D33N/5  
fixing pin

Materials

injection-moulded grip /moulded polycarbonate sheared and formed steel arms die-cast metal joints

Structure finishes

glossy white black soft-touch alu

Insulation class



Note

the lamp's two arms rotate independently, horizontally and vertically, allowing Fortebraccio to take on extreme and functional positions

for photometric data see [www.luceplan.com](http://www.luceplan.com)

D33 FORTEBRACCIO LED

E EI

D33N. led

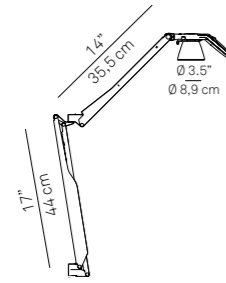

Lamp  
LED 8W  
3000K  
430 lm

A

Photometric data

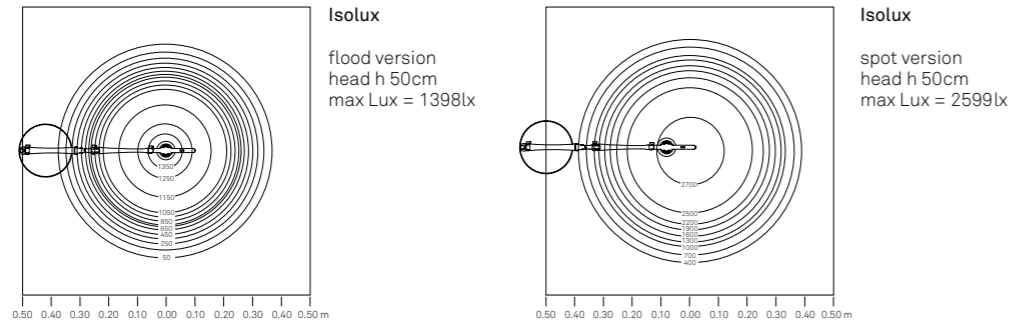

Accessories

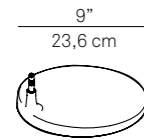

D33N/1  
base



D33N/3  
universal joint

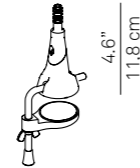

D33N/4  
clamp

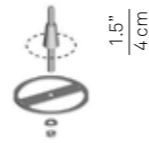

D33N/5  
fixing pin

Adjustable flood-spot  
beam lens (80-45°)

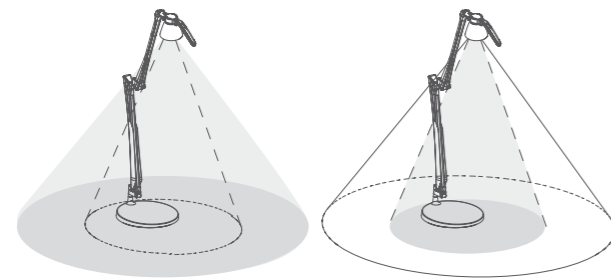

Materials

injection-moulded grip /moulded polycarbonate sheared and formed steel arms die-cast metal joints

Structure finishes

○ glossy white    ● black soft-touch    ● alu

Insulation class



Note

the lamp's two arms rotate independently, horizontally and vertically, allowing Fortebraccio to take on extreme and functional positions